

# CARVER

## Compact Disc Player DTL-100

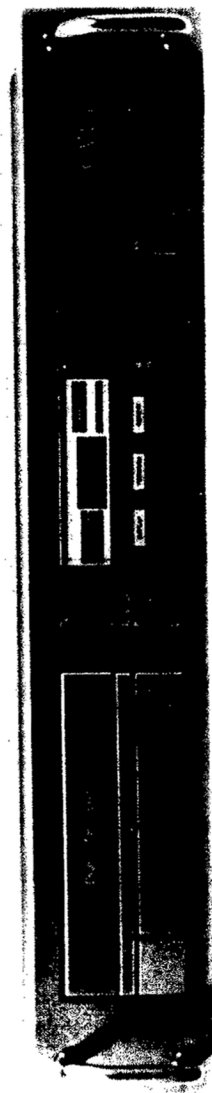

### User's Manual

**FCC NOTICE:** THIS EQUIPMENT GENERATES AND USES RADIO FREQUENCY ENERGY AND IF NOT INSTALLED AND USED PROPERLY, THAT IS, IN STRICT ACCORDANCE WITH THE MANUFACTURER'S INSTRUCTIONS, MAY CAUSE INTERFERENCE TO RADIO AND TELEVISION RECEPTION. IT HAS BEEN TYPE TESTED AND FOUND TO COMPLY WITH THE LIMITS FOR A CLASS B COMPUTING DEVICE IN ACCORDANCE WITH THE SPECIFICATIONS IN SUBPART J OF PART 15 OF FCC RULES, WHICH ARE DESIGNED TO PROVIDE REASONABLE PROTECTION AGAINST SUCH INTERFERENCE IN A RESIDENTIAL INSTALLATION. HOWEVER, THERE IS NO GUARANTEE THAT INTERFERENCE WILL NOT OCCUR IN A PARTICULAR INSTALLATION. IF THIS EQUIPMENT DOES CAUSE INTERFERENCE TO RADIO OR TELEVISION RECEPTION, WHICH CAN BE DETERMINED BY TURNING THE EQUIPMENT OFF AND ON, THE USER IS ENCOURAGED TO TRY TO CORRECT THE INTERFERENCE BY ONE OR MORE OF THE FOLLOWING MEASURES:

REORIENT THE RECEIVING ANTENNA

RELOCATE THE COMPACT DISC PLAYER WITH RESPECT TO THE RECEIVER

MOVE THE COMPACT DISC PLAYER AWAY FROM THE RECEIVER

PLUG THE COMPACT DISC PLAYER INTO A DIFFERENT OUTLET SO THAT THE COMPACT DISC PLAYER AND RECEIVER ARE ON DIFFERENT BRANCH CIRCUITS.

IF NECESSARY, THE USER SHOULD CONSULT THE DEALER OR AN EXPERIENCED RADIO/TELEVISION TECHNICIAN FOR ADDITIONAL SUGGESTIONS. THE USER MAY FIND THE FOLLOWING BOOKLET PREPARED BY THE FEDERAL COMMUNICATIONS COMMISSION HELPFUL:

"HOW TO IDENTIFY AND RESOLVE RADIO-TV INTERFERENCE PROBLEMS".

THIS BOOKLET IS AVAILABLE FROM THE U.S. GOVERNMENT PRINTING OFFICE, WASHINGTON, DC 20404, STOCK NO. 004-000-00345-4.

**CAUTION:** THIS DIGITAL AUDIO DISC PLAYER EMPLOYS A LASER SYSTEM. TO USE THIS MODEL PROPERLY, READ THE OWNER'S MANUAL CAREFULLY AND KEEP IT FOR FURTHER REFERENCE. IN CASE OF ANY TROUBLE WITH THE UNIT, PLEASE CONTACT AN AUTHORIZED CARVER SERVICE STATION.

**CAUTION:** THIS DIGITAL AUDIO DISC PLAYER CONTAINS A LASER SYSTEM AND IS CLASSIFIED AS A CLASS 1 LASER PRODUCT. TO USE THIS MODEL PROPERLY, READ THE OWNER'S MANUAL CAREFULLY AND KEEP IT FOR FURTHER REFERENCE. IN CASE OF ANY TROUBLE WITH THIS UNIT, PLEASE CONTACT AN AUTHORIZED CARVER SERVICE STATION. DO NOT TRY TO OPEN THE ENCLOSURE TO PREVENT BEING EXPOSED DIRECTLY TO THE LASER BEAM.

**RADIO INTERFERENCE REGULATIONS:** THIS APPARATUS HAS BEEN PRODUCED TO COMPLY WITH "DIRECTIVE NO. 776/889/EEC."

**CAUTION:** TO PREVENT SHOCK AND FIRE HAZARD, DO NOT EXPOSE THIS UNIT TO RAIN OR MOISTURE.

**CAUTION:** USE OF CONTROLS, ADJUSTMENTS, OR PERFORMANCE OF PROCEDURES OTHER THAN THOSE SPECIFIED HEREIN, MAY RESULT IN HAZARDOUS RADIATION EXPOSURE. THE COMPACT DISC PLAYER SHOULD NOT BE ADJUSTED OR REPAIRED BY ANYONE EXCEPT PROPERLY QUALIFIED SERVICE PERSONNEL.

**IMPORTANT:**

Record the serial number of this CD player below. The numbers are on the rear panel.

MODEL NO. \_\_\_\_\_

KEEP THESE NUMBERS FOR FUTURE USE.

**DANGER:** Invisible laser radiation when open and interlock failed or defeated.  
**AVOID DIRECT EXPOSURE TO BEAM.**

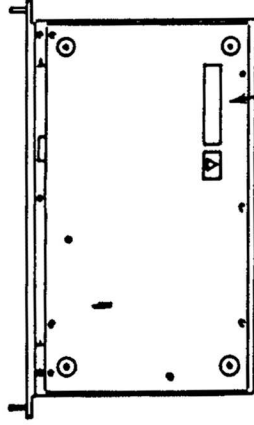
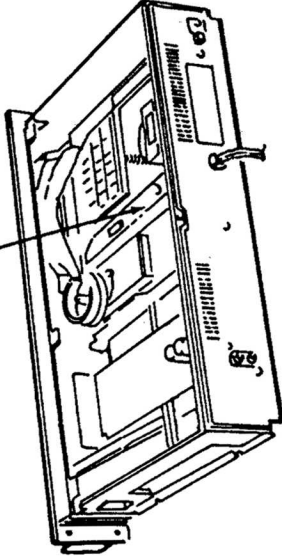

**THIS PRODUCT COMPLIES WITH DHHHS RULES 21 CFR SUBCHAPTER J APPLICABLE AT DATE OF MANUFACTURE.**

Congratulations on purchasing a Carver Compact Disc Player DTL-100. You are about to enter the remarkable world of digital audio with its increased dynamics, frequency response and hiss-free performance.

You have chosen a first-quality CD player with triple laser scanning, true 16-bit sampling, and double resolution digital filter.

In addition, only your Carver Compact Disc Player DTL-100 is equipped with the Carver Digital Time Lens circuitry which further improves digital audio playback on most compact discs.

Because this unit is not like any other type of stereo equipment you have ever added to your system, it is **VERY IMPORTANT** to follow all unpacking, hook-up and operation instructions. Be sure to keep this manual handy for reference.

We hope you enjoy a lifetime of musical enjoyment from your Carver Compact Disc Player.

# CARVER

**Powerful · Musical · Accurate**

## UNPACKING AND SETTING UP YOUR CARVER COMPACT DISC PLAYER DTL-100

### A. REMOVING TRANSPORT SCREWS

To protect the Carver Compact Disc Player DTL-100 during transport, two red transport screws have been used to secure the delicate laser assembly.

These screws are attached to the **BOTTOM** of the DTL-100.

**THEY MUST BE REMOVED BEFORE ANY ATTEMPT IS MADE TO OPERATE THE UNIT!**

1. Gently turn the Carver Compact Disc Player DTL-100 on its **LEFT** side. Rest it on a soft non-abrasive surface if possible.
2. Locate the red transport screws near the front and left side of the unit.

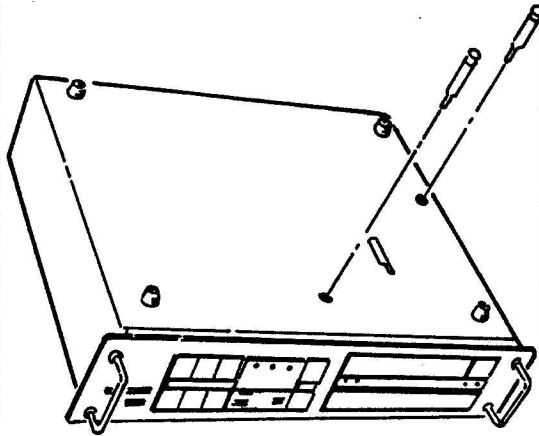

3. Remove the screws using a Phillips head screwdriver.
4. Keep the red transport screws in a safe place so that they may be replaced before moving the unit.

5. Should you move, or need to ship the Carver Compact Disc Player DTL-100 for service, replace the red transport screws using the same procedure. Make sure that there is no disc in the player before putting the screws back.

### B. PLACEMENT OF THE DTL-100

Naturally, you will wish to place your CD player with other stereo components. However, you should make sure of the following:

1. The Carver Compact Disc Player DTL-100 should not be placed directly next to, or on top of your receiver or tuner.

To avoid possible interference, it is suggested that the DTL-100 be positioned at least one component away when stacking or placing your equipment in a row on a shelf. Also avoid placing the DTL-100 next to or on top of a television set or cable converter box.

2. Make sure that no other components are placed **ON TOP OF** the DTL-100. Also avoid placing stacks of heavy records or a speaker on top of the unit.

3. As with all high-quality components, avoid placing the DTL-100 in direct sunlight or where it will receive unnecessary hot air currents from an amplifier or heat outlet.

### C. CONNECTING THE DTL-100 INTO YOUR STEREO SYSTEM.

The Carver Compact Disc Player DTL-100 is extremely simple to connect into your system, since it connects with one set of patch cords directly into your pre-amplifier, receiver or integrated amplifier.

1. Make sure the DTL-100 and the rest of your stereo system are turned off or disconnected.

On the back of the DTL-100, locate the two sockets marked LINE OUT. They're near the left side of the DTL-100's rear panel when viewed from the back.

2. Connect one end of a red patch cord plug to the top (RIGHT) socket on the DTL-100 back; connect the corresponding white patch cord plug to the lower (LEFT) socket.

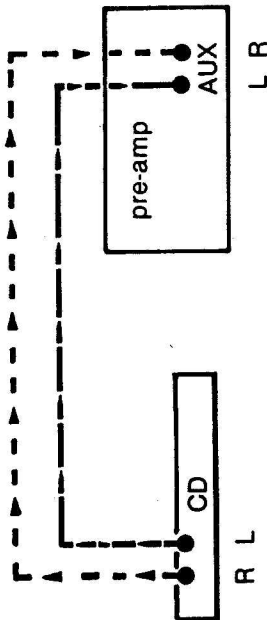

Now you are ready to connect the Carver Compact Disc Player DTL-100 to the back of your pre-amplifier, integrated amplifier or receiver (referred to from now on simply as "your pre-amplifier")

3. Check the back of your pre-amplifier or consult the owner's manual that came with the unit. There are several possible places to connect the DTL-100.

a. The most common pre-amplifier inputs are labeled AUX and correspond to the Auxiliary position on the source switch.

b. Some newer pre-amplifiers have an additional set of input sockets labeled DAD or CD and are intended specially for players like the DTL-100.

c. If your unit lacks either of these types of input sockets, you may connect the DTL-100 to the TAPE PLAY or TAPE IN inputs. If you already have a cassette deck, use the second set of inputs which are included on most receivers and pre-amplifiers.

**NOTE: DO NOT UNDER ANY CIRCUMSTANCES PLUG THE CARVER DTL-100 INTO PHONO INPUTS, EITHER MOVING COIL OR MOVING MAGNET!**

4. When you have decided where you would like to connect the DTL-100 to your pre-amplifier (most likely, AUX), plug the other end of the DTL-100's patch cords

in. Hook the red plug to the RIGHT pre-amplifier input socket and the white plug to the LEFT socket.

Now you are ready to connect the DTL-100 to an AC outlet.

5. You may plug the Carver Compact Disc Player directly into a wall plug or into a convenience power outlet on your pre-amplifier. The DTL-100 is rated at 16.5 watts which is well within the limits of most pre-amplifiers including those made by Carver Corporation. Consult your owner's manual if you are in doubt.

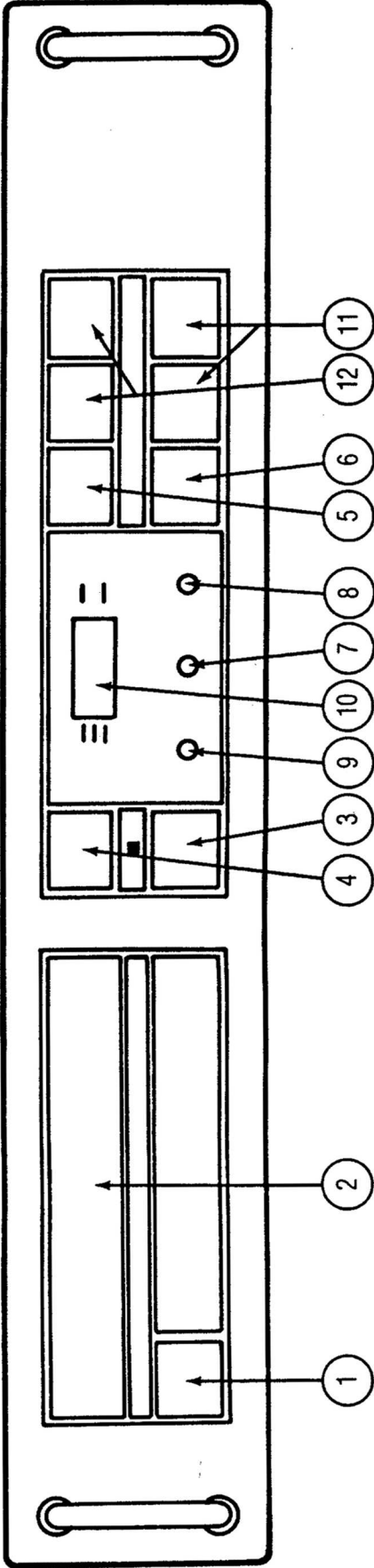

## GETTING TO KNOW YOUR CARVER COMPACT DISC PLAYER

Here's a quick overview of the versatile controls on your new Carver DTL-100. Complete instructions for operation will follow later in the manual.

1. **POWER**  
Push to turn on the DTL-100. If there is already a compact disc in the disc tray, the unit will set itself to **PLAY** mode.
2. **DISC TRAY**  
This is where you put the compact discs. The tray works like a drawer, moving in and out as you activate the **OPEN/CLOSE** button.

**NOTE:** The tray will also close by itself if you push it in lightly. Keep it closed when you're not using the DTL-100 to keep the laser pick-up clean and protected.

3. **DIGITAL TIME LENS**  
Here is the feature which sets the Carver DTL-100 apart from all other CD players. It is an extremely sophisticated circuit which prevents the loss of sonic front to back depth imaging, as well as the excessive brightness and brittleness audio professionals often associate with compact disc recordings. How and when you use it will depend on your choice of discs, your type of speakers and

your own musical taste. We have included an explanation of why the Digital Time Lens was invented and what it can do for you at the end of this manual.

4. **OPEN/CLOSE BUTTON** Pressing this button slides the disc tray out. Pressing it again causes the tray to retract back into the DTL-100.

5. **PLAY BUTTON**  
Disc playback begins when you touch this square panel.

6. **STOP/PAUSE**  
This is a dual-purpose button.

Pressing it **ONCE** during playback temporarily interrupts operation. You might think of it as a cueing lever on a turntable, since it does not move the laser pick-up to another section of the disc.

Pressing the **STOP/PAUSE** button **AGAIN** (twice) moves the internal laser pick-up back to the beginning of the first selection on the disc. It is analogous to the "reject" lever on many turntables which returns the tonearm past the beginning of a record.

**Remember:**

- Push **ONCE** for **PAUSE**.
- Push **TWICE** for **STOP**.

While pressing **STOP/PAUSE** twice does reset the laser playback unit, the DTL-100 is still turned on. You must press the **POWER** button to turn the unit completely off.

## 7. PROGRAM

This button is part of the Carver Compact Disc Player DTL-100's sophisticated programming or playback system and is used when setting or checking programming of selection order. A detailed description of its functions is presented later in this manual.

## 8. REPEAT

Pressed **ONCE**, this button activates a **REPEAT PLAYBACK** cycle. Pressing it **AGAIN** cancels the repeat playback function.

## 9. DISPLAY

Two or three different displays can be presented on the multi-function display by pressing this button. They occur in a repeating order:

**NO.** —> **ELAPSED TIME** —> (back to **NO.**)

When in **PLAY** or **PAUSE**.

**NO.** —> **ELAPSED TIME** —> **TOTAL TIME**

—> (back to **NO.**)

When in **STOP**.

#### 10. MULTI-FUNCTION DISPLAY

This LED display panel helps you keep track of functions.

- a. The large LED section displays selection number, programmed order, and delivers various messages.
- b. Music No., Elapsed Time and Total Time LED's explain the numbers displayed on the LED panel.
- c. Music Repeat signals that this feature is in operation.
- d. Index alerts you that a CD has special index codes on it. These are explained farther on.

#### 11. < REV and > FWD

These correspond to the reverse and fast forward buttons on a tape deck and move the laser pick-up ahead or back through the music.

#### 12. - and +

Digital disc technology also allows you to move forward or back ONE SELECTION at a time. Both the MINUS (-) which lets you move back through the songs, and PLUS (+) which moves ahead through the selections or "bands", can be used in conjunction with the STOP/PAUSE and PLAY buttons. This is covered further on in this manual.

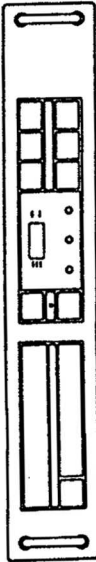

### PLAYING A CD DISC WITH THE CARVER COMPACT DISC PLAYER DTL-100

Now you are ready to enjoy the amazing sonic clarity of compact discs.

1. Press the DTL-100's POWER BUTTON. You'll see the word "disc" displayed on the large LED display.
2. Press the OPEN/CLOSE button. The tray will slide out and the display will read "OPEN".
3. Remove a compact disc from its case and place it LABEL SIDE UP in the disc tray. While compact discs are much less prone to wear and tear than records, you should still be careful with your CD's, gently grasping them on the edges only. (see HANDLING CD DISCS section at the end of this manual)
4. Press the OPEN/CLOSE button again. The tray will retract and, after about three seconds, the multi-function display will switch to MUSIC NO. and the large LED display will read out the total number of selections on the compact disc.

The DTL-100 is now in the playback standby mode awaiting further instructions from you.

**NOTE: IF THE LED DISPLAY CONTINUES TO READ "disc", AFTER THE DISC TRAY HAS RETRACTED, YOU HAVE PUT THE DISC IN UPSIDE DOWN. IF THE TRAY SLIDES BACK OUT BY ITSELF AFTER ABOUT FOUR SECONDS, THERE IS SOME FOREIGN MATTER LODGED IN THE TRAY ALONG WITH THE COMPACT DISC.**

5. If you press the DISPLAY button TWICE, the elapsed time LED lights and

the display will read out the TOTAL ELAPSED TIME OF THE ENTIRE CD. This is especially handy when getting ready to make tape recordings.

6. To begin enjoying digital sound, simply press PLAY.

If nothing happens or the music sounds strange at this point, consult the "Troubleshooting" section farther on.

**A PLAYBACK SHORTCUT.** If you're familiar with a compact disc and don't need to know the number of selections and playback time, you can simply PRESS PLAY AFTER PLACING THE DISC IN THE DISC TRAY. Your Carver Compact Disc Player DTL-100 will take over, retracting the disc tray and beginning play automatically.

**TO PAUSE during play, simply press the STOP/PAUSE button ONCE.** Playback will stop at that point on the disc. Press PLAY to resume playback.

**TO STOP play at any time, simply touch the STOP/PAUSE button twice.** Then press OPEN/CLOSE and the compact disc will slide out on the disc tray.

**FAST FORWARD and REVERSE are used just as you would on a cassette deck.** For the first three seconds, these operations are carried out at low speed which allows you to back-up or advance just slightly. After three seconds, the operations switch to a high speed which moves fairly rapidly through the music.

During these operations, you will still be able to hear the music at 1/4 volume but speeded up. If you don't want to listen, activate the FAST FORWARD or REVERSE after touching the PAUSE button. Now the operations will be carried out in silence.

The FAST FORWARD and REVERSE buttons can also be used for indexing which is covered farther on.

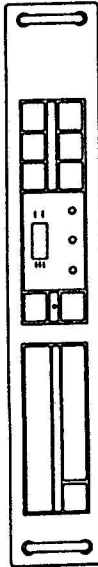

## MUSIC SEARCH WITH THE CARVER DTL-100

The - and + keys allow you to move forward or back to the exact beginning of a selection, or move quickly ahead or back without going through all the intervening music.

To move ahead one selection when in PLAY, press + ONCE. You will notice that the LED display will now present the number of the next song.

To move ahead more than one selection, HOLD DOWN the + key. You will see the selection numbers count up on the LED display.

The - button works the same way to move you back through one or more selections.

You can also use the - and + music search keys in conjunction with STOPI/PAUSE, as well as play. Touching the STOPI/PAUSE button once or twice determines what happens when you then touch - or +:

+

PAUSE and places the laser pick-up at the beginning of the previous selection or farther if the - button is held down.

places the laser pick-up at the beginning of the next selection or farther if the + button is held down.

STOP and stops the laser pick-up at the beginning of the last or previous selections.

stops the laser pick-up at the beginning of the next or succeeding selections.

PLAY and immediately begins playing the last or previous selections

immediately begins playing the next or succeeding selections.

If the + button is held down long enough, the DTL-100 will, of course, reach the last selection. It will not go beyond the beginning of the last song on the compact disc, however, and will begin playing that selection rather than proceeding to the very end of the disc.

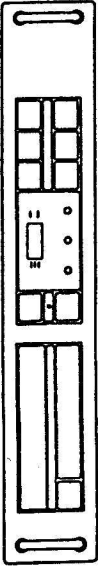

## PROGRAMMED PLAYBACK, REPEAT AND INDEXING WITH THE CARVER DTL-100

The Carver Compact Disc Player allows you great versatility in the order in which you listen to selections on a compact disc. You can skip selections you don't wish to hear, make up a new order or repeat a favorite more than once.

These operations are carried out using the PROGRAM key in conjunction with the -, +, FAST FORWARD, REVERSE and REPEAT buttons.

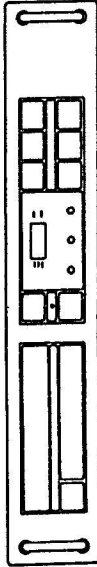

### A. PROGRAMMED PLAYBACK.

This feature allows you to hear selections in any order desired with up to nine different songs programmed at one time. Between each programmed selection, the DTL-100 will insert a three second pause before continuing.

1. Set the unit to STOP (playback standby mode)
2. Press the PROGRAM button. The LED display will display "P 1". Now you are ready to program in your first selection.
3. Use the + or - keys to move to the desired selection. You will see its number flashing ahead of the "P 1" on the LED display.
4. When you have located your first programmed selection, press the PROGRAM button again. You will see the LED display change to "P 2". You are now ready to pick a second selection using the - and + buttons.
5. After you have selected each song, press PROGRAM again to move on to the

next of up to nine selections in any order. You may also repeat a selection as part of the order.

6. When you have finished programming the selection order, press PROGRAM again. After three seconds, the LED display will read "o o P 1". You can check the total length of your newly programmed order by touching DISPLAY.

TO PLAY BACK A PROGRAM IN ORDER, simply press PLAY. If you wish to advance or back-up, remember that the - and + keys will now be treating your new order as the sequence in which it advances or backs up. For example if you had programmed a disc to play selections 3, 5, 6, 7, and 8 on a compact disc, the - button would not take you any closer to the beginning of the CD than selection 3. Likewise, the + button would stop at the beginning of selection 8.

FAST FORWARD, REVERSE and PAUSE all work normally during the playback of a programmed order.

TO CHANGE A PROGRAM ORDER, press STOP. Then go into PROGRAM as in the previous instruction and "step" through using the sequence to find the ones you want to change. When you find a program that you want to change, use the same procedure as when initially programming. To end your "reprogramming", just hit PROGRAM again. CANCELLING A PROGRAMMED ORDER. Naturally, you don't want the same order on the next compact disc you play. The DTL-100 takes care of this when you press the OPEN/CLOSE button. As the tray slides out, the program order is cancelled.

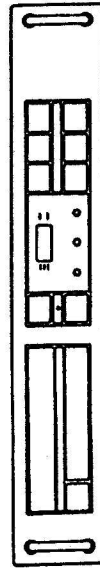

### B. REPEAT PLAYBACK

This function lets you repeat a whole compact disc or just certain selections using the programming feature.

## TO REPEAT A CD FROM BEGINNING TO END,

1. Press the REPEAT button. The corresponding LED will light in the multifunction display. As long as this light is on, the CD will play again and again.
2. To cancel the repeat function at any time while in PLAY, simply press REPEAT again. The LED will go out indicating that repeat playback has been cancelled.

TO REPEAT ONE OR MORE SELECTIONS, just follow the instructions for PROGRAMMED ORDER; except this time, do not advance or back up to program different songs when programming. You could repeat the same song up to nine times or different songs more than once up to a total of nine times.

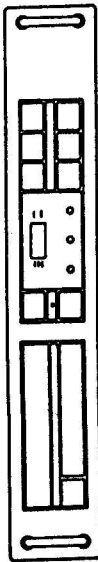

## C. INDEX PROGRAM SEARCH.

A compact disc can hold an impressive amount of music. Significantly more than a standard LP. While this makes it an excellent medium for classical music, it also makes + and - selection feature less useful in some cases.

For example, a three-movement symphony would only display three selections, or just ONE if the movements blend into each other without a pause. The developers of the CD took this into account and devised a way to further subdivide selections into INDEXES. If a compact disc has been "indexed" it will be noted in the program booklet which came with the CD. Consult the index listing to determine the significance and placement of each index segment.

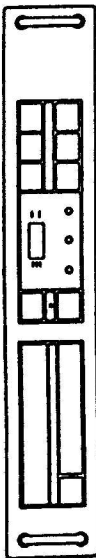

## D. TO SEARCH THROUGH A SELECTION'S INDEXES,

1. Place the DTL-100 in STOP (playback standby mode)
2. Search for the index using the FAST FORWARD and REVERSE buttons. The INDEX LED will light up, indicating the presence of each successive index and the LED read-out will display the SELECTION number first, then the INDEX number. For example, index three on selection two would be displayed as "2 3".
3. When you reach the index you are seeking, press PLAY. Playback will begin from the point where the index was programmed onto the disc by its manufacturers.

## ABOUT DIGITAL RECORDING AND CD'S

Digital recording is a relatively new method of storing sound impulses and didn't become a commercial reality until the late 1970's. It is based on computer technology rather than electronics and magnetism as is the older analog method of recording.

Analog recording converts sound impulses into varying amounts of electrical energy, which is then used to magnetize a tape to varying degrees. The more musical impulses in a given passage of music, the more magnetism is imparted to that part of a tape as it goes past the recording head.

The trouble has always been the physical limitations of tape. It simply has a finite limit to how much energy it can record. That limit may very well be under the maximum dynamics of a bass drum, a rock band or a symphony in the throes of a Wagner overture.

Thus, recording engineers have had to reduce the overall signal strength to allow "headroom" for unexpected loud passages. This would be fine if tape were completely silent. But there is residual energy even in unrecorded tape which is heard during playback as tape hiss. If a signal is recorded too softly, this hiss becomes apparent. In practice the signal-to-noise ratio is always less than optimal since it has been lowered to allow for loud parts.

Tape is also limited in the frequency range which it can reproduce without distortion.

Corresponding problems occur when the master tape is made into a vinyl recording. It is exceedingly hard to cut record grooves which exactly mirror even the dynamic range and frequency response of the tape recording, much less the original performance. Add additional hiss caused by the surface of the vinyl and the compromises made during production to squeeze more time out of a record and the results are often a far cry from the live performance.



(To the credit of the recording industry, there ARE many excellent analog discs, some which are equal to or, according to critics, better than many compact discs. They are examples of painstaking skill in every step of the process—and are often much more expensive than compact discs. More on that when we examine Bob Carver's Digital Time Lens.)

Digital recording converts sound into pure information, strings of 1's and 0's which can be recorded perfectly without concern over the limitations of magnetic tape.

A good analogy is a conveyor belt filled with an endless line of fruit baskets, representing magnetic tapes's recording ability. Conventional analog recording fills each basket with "fruit". A small amount for a quiet passage. Heaping full for a loud sound. But what often happens is that there is more "fruit" than the basket can hold. The baskets cannot be made bigger. You can move them past faster so each one holds less, but still, a loud bass drum boom or a massive synthesizer note can exceed the capacity.

Digital recording is like an inspector who counts the fruit that would go into each basket. He writes down a description on a piece of paper and drops it in each basket. Nothing more. Just a precise description. With this approach, it doesn't matter how much "fruit" (music) needs to go in a basket. The inspector (analog to digital converter) can write down that bass drum crash accurately as "4.7 tons of apples" and the description still fits in the basket. He can also write down the EXACT color, size and shape of the fruit, corresponding to digital's ability to record wide frequency response and finer detail.

Our "endless conveyor belt of written descriptions" is now transferred to a compact disc which is imprinted with microscopic pits, representing the individual data bits exactly as recorded.

The Carver Compact Disc Player DTL-100 uses a solid state semiconductor diode laser to illuminate the track of pits on the disc surface. The laser is reflected into a photo-diode which translates the on-and-off light impulses into an electronic signal.

## THE CARVER DIGITAL TIME LENS

Many professional musicians, audiophiles and audio journalists have praised the quietness, dynamic range and superb frequency response of digital discs—and then expressed a lingering disappointment over how actual commercial examples sounded. The complaint boils down to a lack of ambience and spacial detail, along with an overly bright, hot-sounding midrange.

When Bob Carver obtained his first compact disc player, he too noticed subtle differences in many compact discs. The three-dimensional perspective which his analog system provided in lush abundance sometimes evaporated into a flat brittle wasteland.

He then purchased no less than 23 CD's and their analog counterparts and set about quantifying the differences. True, the compact discs had better dynamic range and richer, tighter bass...but testing uncovered two inherent *measurable* flaws:

First, the overall frequency balance had shifted slightly with the CD putting out more energy above 400Hz. Also, the amount of left-minus-right channel information differed by about 1.25 dB.

The left-minus-right (L-R) component of stereo carries the three-dimensional part of sound field information. Even 1.25 dB less produced a noticeable reduction in imaging, spacial positioning and other psychoacoustic factors that put the realism into music.

Bob Carver's Digital Time Lens circuitry adjusts the ratio of L-R back into proportion with the L + R and restores the octave-to-octave balance originally intended by the musician and recording engineer.

It does this by treating the L-R component of the digital disc differently than the L + R. Two equalization curves are necessary to make the disc sound like its analog counterpart. In addition to equalizing the two bands differently, the Digital Time Lens also restores the proper balance by increasing the L-R component back to realistic levels.

Then special circuitry translates the digital bits back into analog electrical impulses for your amplifier.

The sound you hear will have 1) greater dynamic range, 2) wider frequency response and 3) no tape hiss. And, within reasonable limits, the compact discs are impervious to scratches, dust, dirt, warping and finger prints.

For a more detailed description of digital technology, we suggest many excellent articles in recent stereo magazines as well as specialized publications devoted specifically to digital audio.

Since the equalization curves now differ, the Digital Time Lens corrects for the resulting time arrival difference by delaying the L + R signal. Then the two signals arrive at the next step in the circuitry without time domain errors, yet with corrected equalization and proper L-R/L + R balance.

Which compact discs you choose to use the Digital Time Lens on will vary with your musical tastes and system. In most current discs, the improvement is noticeable. This unique circuit adds the finishing touches of sonic accuracy and realism. It turns an innovation into near musical perfection.

## HANDLING COMPACT DISCS

**NOTE:** The Carver Compact Disc Player has been designed specifically for reproduction of compact discs bearing the



No other discs can be reproduced.

While playback is not impaired by small dust particles or slight scratches, larger imperfections can prevent the player from tracking the disc. These mis-trackings can cause the player to skip ahead or emit a small burst of high frequency noise.

The Carver Compact Disc Player DTL-100 uses unusually sophisticated tracking and error correction circuits which will read discs virtually unplayable on some compact disc players. Still, the discs should not be abused or handled carelessly.

**GRASP THE DISC** only on its edges. Another safe method is to put a finger in the center hole, using the thumb to hold the disc steady.

**RETURN COMPACT DISCS** to their cases after use to avoid serious scratches which can occur from stacking them, sliding them on rough surfaces or leaving them out in direct sunlight.

**TO CLEAN A COMPACT DISC**, wipe the surface with a soft cloth, dry or moistened with water. **DO NOT** use conventional record cleaning products, anti-static sprays or alcohol. Wipe using straight motions from center to outside, as if you were tracing the spokes of a wheel.

## TROUBLESHOOTING THE CARVER COMPACT DISC PLAYER DTL-100

Simple measures will correct most of the problems encountered in setting up and operating the DTL-100. If none of these solutions works for you, **DO NOT** attempt to open or repair the DTL-100. Disconnect the unit's power and patch cords and contact your nearest Carver Service Station.

### PROBLEM SOLUTIONS

<b>POWER FAILS TO TURN ON WHEN POWER BUTTON IS PRESSED.</b>	Check to make sure the power plug is securely in its socket.
<b>PLAY BACK DOES NOT BEGIN.</b>	Reload the disc with the label side up OR check the disc for excess dirt or foreign matter. OR static discharge may have caused an error in the micro-processor. Simply turn unit off and back on again. If static discharge is a problem in your environment, anti-static spray, available at any computer store, is a good solution. Spray the carpet around your stereo installation and the DTL-100 chassis <b>LIGHTLY</b> . <b>DO NOT SPRAY THE DISC!</b> The disc is manufactured with permanent anti-static plastic.
<b>NO SOUND.</b>	Check output cables for proper connection OR Make sure pre-amplifier controls are set properly.
<b>SOUND "SKIPS"</b>	Change location of unit to avoid vibrations, physical shock OR Check condition of disc to detect dirt or deep scratches.
<b>"disc" FLICKERS IN THE LED DISPLAY</b>	Moisture has condensed on the optical display. Wait 20-30 minutes after turning the DTL-100 on.
<b>"disc" APPEARS IN DISPLAY BUT PLAY WILL NOT WORK</b>	Compact disc is not providing lead-in on information check for damage. Return and/or replace the disc as necessary.
<b>HUM</b>	Replace cables or check pre-amplifier.
<b>NOISE IN TUNER OR RECEIVER</b>	Move the DTL-100 farther away from the tuner to eliminate interference.

## CARVER COMPACT DISC PLAYER DTL-100 SPECIFICATIONS

- FREQUENCY RESPONSE, 5Hz - 20kHz @ 0dB  
± 0.5dB
- TOTAL HARMONIC DISTORTION @ 1kHz 0.05%
- SIGNAL TO NOISE RATIO, 96dB
- CHANNEL SEPARATION, 86dB @ 1kHz
- DYNAMIC RANGE, 96dB
- WOW AND FLUTTER, Unmeasurable
- OUTPUT VOLTAGE, 1.9V (F.S.)
- POWER CONSUMPTION, 16.5 Watts

## CARVER LIMITED WARRANTY

Your Carver Compact Disc Player DTL-100 is warranted against defects for one year from date of purchase. Within this period, we will repair it without charge for parts and labor. Simply write to or call Carver Corporation (attention: Customer Service Department), P.O. Box 1237, 19210 33rd Ave. W., Lynnwood, WA 98046, (206) 775-1202.

You will be directed to an Authorized Carver Service Station or receive instructions to ship the unit to the factory. Please save the original shipping carton and packaging material in case shipping is required. Please do not ship by Parcel Post.

Be sure you have specific authorization from Carver Corporation and include a complete description of the problem, the associated components and connections, and a copy of your purchase receipt. Initial costs are not validly Carver Corporation; return shipping costs will be Carver Corporation's responsibility. Carver Corporation's warranty is limited to the repair or replacement of any defective product and shall not include consequential or incidental damages. Carver Corporation's warranty does not apply to products which fail due to misuse or abuse. Carver Corporation's warranty does not allow limitation on how long an implied warranty lasts and/or do not allow the exclusion or limitation of incidental or consequential damages, so the above limitations may not apply to you.

This Warranty gives you specific legal rights, and you may also have other rights which vary from state to state. We suggest that you attach your purchase receipt to this Warranty and keep them in a safe place.

Thank you for your choice of a Carver Corporation product.

Notice, the preceding warranty information is exclusive to the United States. Please see your local Carver dealer or distributor for the correct information for your area and locale.

Specifications and features subject to change without notice.